

BONDY

Chariot à bagages en fer avec châssis en plaques de fer et barre de penderie. Plateau en chêne rustique sur quatre roues, deux fixes et deux pivotantes, et équipé d'un joint en caoutchouc de protection contre les chocs. Finitions disponibles : - acier industriel - peinture dans les couleurs Apir ou dans n'importe quelle teinte du nuancier de couleurs RAL Hauteur : 172 cm Largeur : 61 cm Profondeur : 117 cm Poids : 79 kg

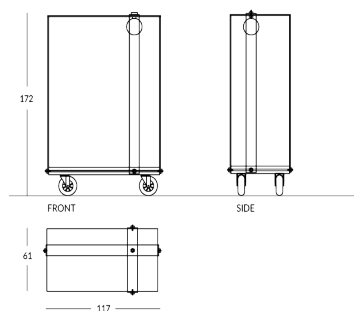

Versione



Finiture Metalliche | Metal finishes | Finitions métalliques



Acier
industriel

Finiture Verniciate | Painted finishes | Finitions peintes

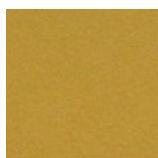

Or

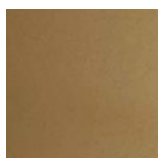

Or antique

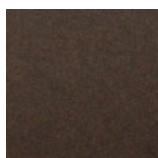

Bronze

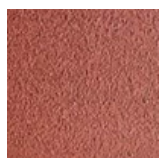

Simil Corten

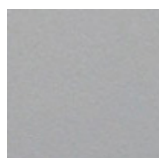

Silver



Tortora (Ral
1019)

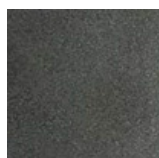

Canna di
Fucile

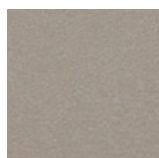

Antique Lumi
ère

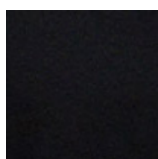

Matt black
(Ral 9005)



Polished
black (Ral
9005)

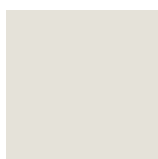

Matt white
(Ral 9010)



Gris foncé
(Ral 7016)



Gris clair (Ral
7042)



Ral